

Using the pan head

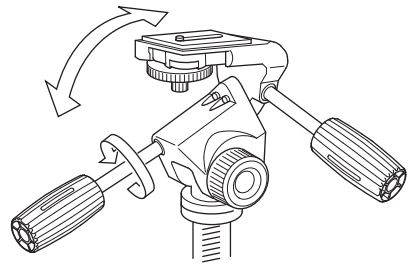

1. Loosen the panning handle to move the head freely front and rear.

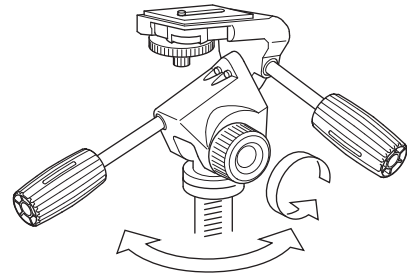

2. Loosen the panning lock knob, to rotate the head.

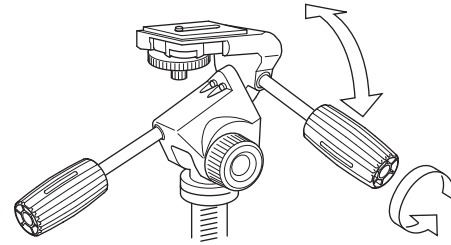

3. Loosen the vertical tilt handle to adjusted the level.
The pan head is specially lubricated for smooth movement.

Attaching a camera

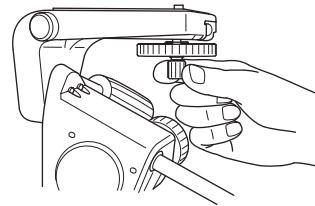

1. Hold the camera firmly, when the camera mounting screw turn to engage the threads.

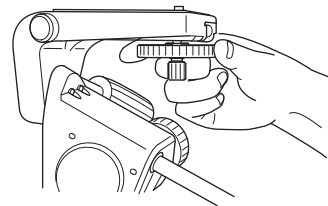

2. Lock the camera tightly with the knurled camera locking knob.

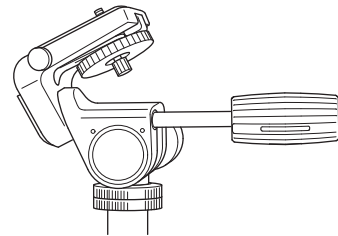

3. Tilting the head forward makes easier to attach the camera.

Bubble levels

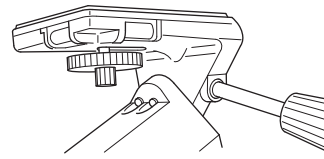

Two bubble levels are built-in for vertical and horizontal positioning.

Changing the camera mounting screw

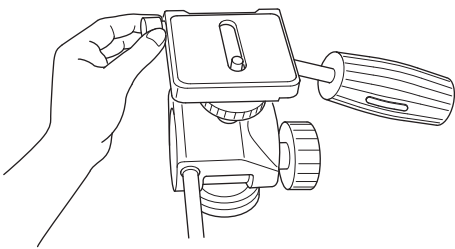

1. Both 1/4" and 3/8" camera mounting screws are supplied.
The unused screw can be stored in the side of the camera platform.

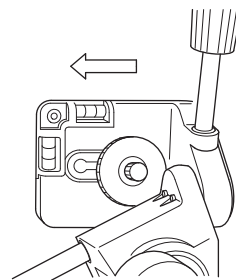

2. Remove the camera mounting screw through the large end of the mounting track.
It's a good idea to tighten the camera locking knob when a camera is not attached to prevent loss of the mounting screws.

Panning guide

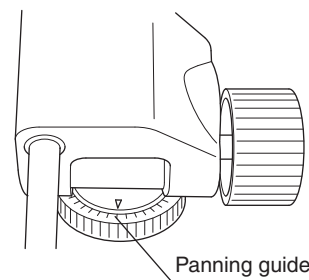

A rotating scale at the base of the head makes it easy to set exact shooting angle.
To begin, set the mark at the base of the head on "0".

Care of the tripod

- DO NOT apply any grease or oil to this product.
- Clean with a mild detergent and a soft cloth only.
- DO NOT use close to flame. Avoid extreme heat.

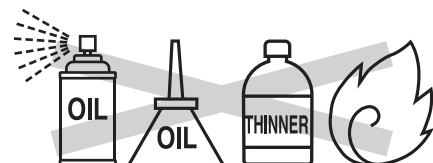

Slik Corporation reserves the right to make changes in design and/or improvements on the products without any obligation and ad vanced notice.

SLIK CORPORATION
853 Kayama, Hidaka City, Saitama 350-1231, Japan ©2017

SLIK®

SH-909, 908 Pan head

Operating Instructions

Thank you very much for choosing SLIK SH-909, SH-908 Pan head. The SLIK Corporation has designed your pan head to be a sturdy, rugged, dependable product that will provide you with many years of satisfactory use.

Please take a few moments to read these operating instructions carefully before use so that you can take full advantage of your Pan head's many fine features. Retain this operating instruction sheet in case you might want to refer back to it.

⚠ Caution

This caution icon refers to information pertaining to important safety procedures in preventing injuries, or damages which may occur as a result of mishandling this product.

🚫 Prohibition

This prohibited icon refers to information pertaining to prohibited contents. Please refer to instructions closely to avoid accidents.

Specification

SH-909	
Height	140mm (5.6in)
Weight	1.710g (3.8lbs)
Camera mounting screw	U1/4" · U3/8"
Tripod mounting screw	U3/8"

SH-908	
Height	135mm (5.4in)
Weight	1.410g (3.2lbs)
Camera mounting screw	U1/4" · U3/8"
Tripod mounting screw	U3/8"

J274-4

Components

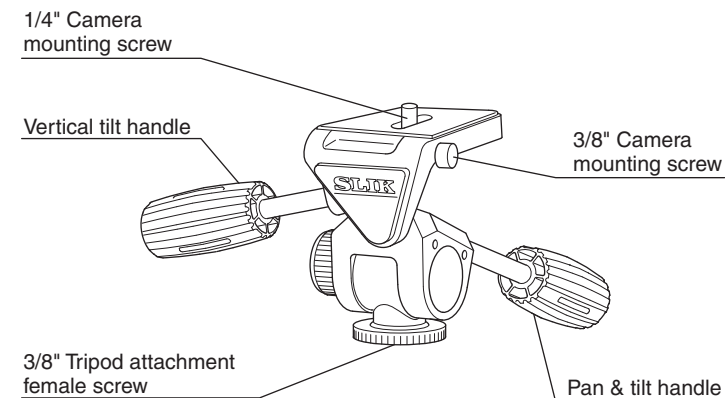

Carrying the tripod

🚫 Prohibition

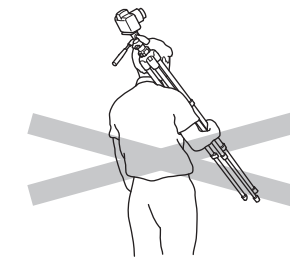

Carrying a tripod with a camera left on can result in unexpected accidents. We recommend you to remove your camera while carrying the tripod.

Equipment that can be loaded on this tripod

This product has been designed to handle equipment weighing under 12 kgs (26.4 lbs). Do not overload. Some equipments weighing under 12 kgs (26.4 lbs), such as long lenses, may not balance well due to its weight distribution.

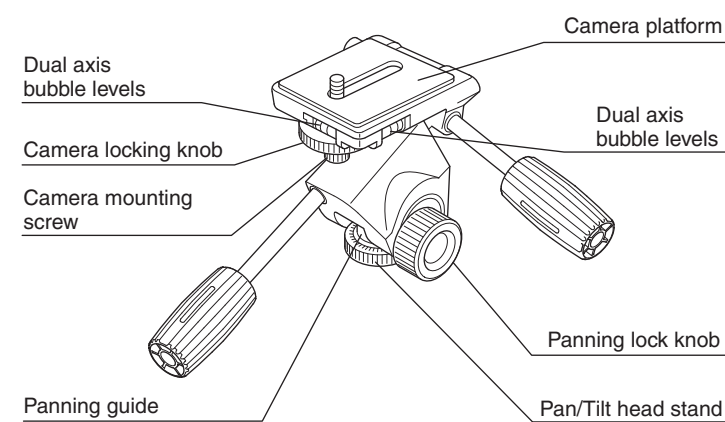

(SH-909)

Setting up

⚠ Caution

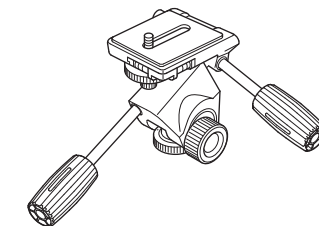

Make sure all levers, knobs, and handles on the tripod are securely tightened and all three legs are opened all the way to prevent accidental equipment fall or tripod tipping over.

Install the pan handles

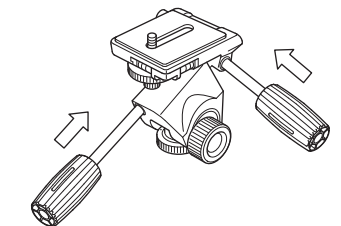

The pan handles are installed as shown with the handle on the left for pan and tilt movement the handle on the right for vertical tilt. Both handles are same. You can install the handle either way.

Storage

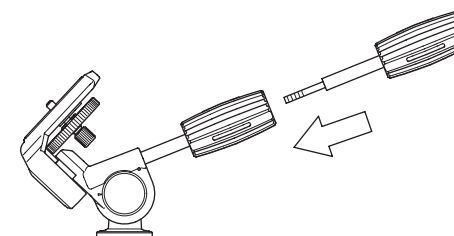

Remove the vertical tilt handle from the panhead, and screw into the back of the pan & tilt handle.

Attach the head to the center column

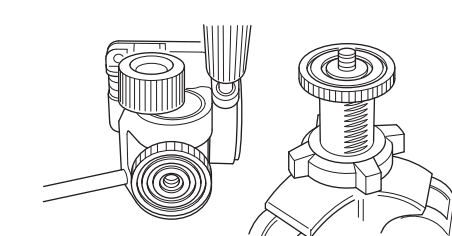

The head is installes by screwing it onto the center column's 3/8" threaded post hole.

Removing the head from the center column

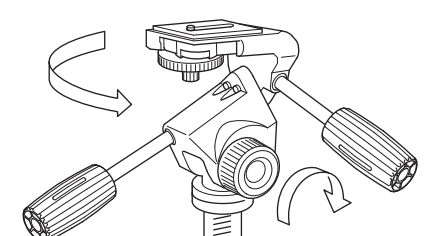

Lock the panning lock knob tightly. Grasp the pan handle and turn the whole head counter-clockwise to loosen. Then loosen the panning lock knob and it will be easy to unscrew the head by rotating the base.