

Operating Instructions

Thank you very much for choosing SLIK product. SLIK Corporation has designed to be a sturdy, rugged, dependable product that will provide you with many years of satisfactory use. Please take a few moments to read this operating instruction carefully before use so that you can take full advantage of many fine features. Retain this operating instruction in case you might want to refer back to it.

⚠ Caution

This caution icon refers to information pertaining to important safety procedures in preventing injuries, or damages which may occur as a result of mishandling this product.

🚫 Prohibition

This prohibited icon refers to information pertaining to prohibited contents. Please refer to instructions closely to avoid accidents.

Specification

Folded length	675mm
Max. operating height	1,375mm
Bowl leveler	60mm
Weight	1,960g
Tilt range	+80/-67°

T048

Components

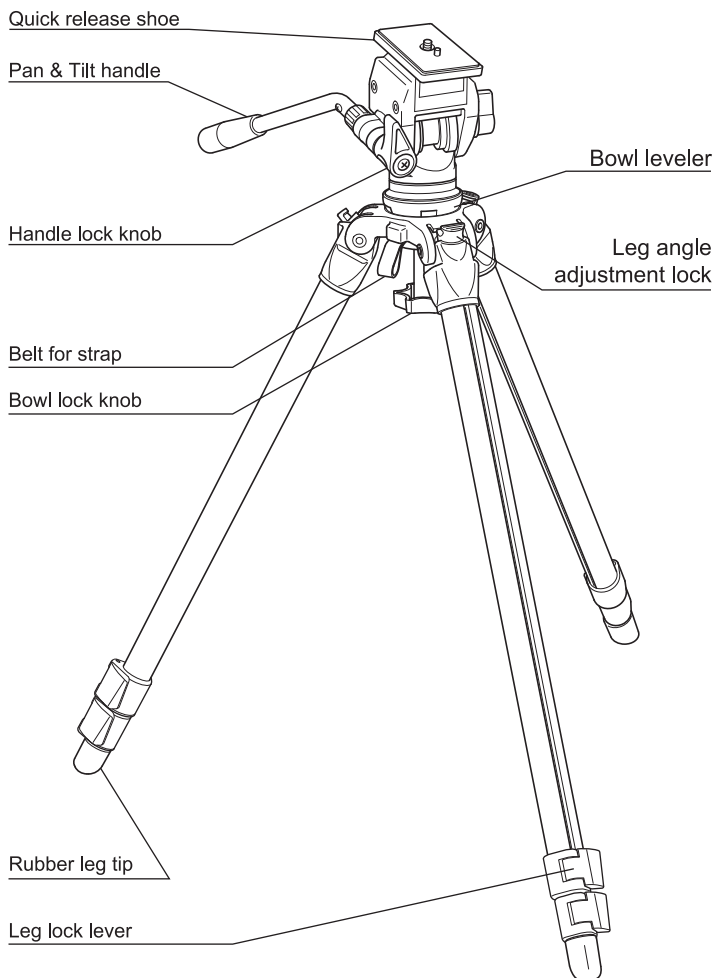

Pan Head

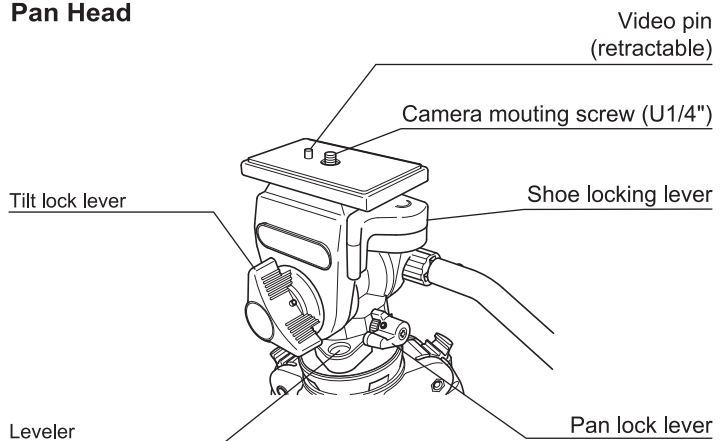

*The Bubble Level on the tripod does not guarantee that the equipment is level. Please check the level on your equipment if necessary.

Load capacity

🚫 Prohibition

This product has been designed to handle equipment weighing under 3 kgs. Do not overload. Some equipment weighing under 3 kgs, such as long lenses, may not balance well due to its weight distribution. In such cases, please use a larger tripod.

Carrying the tripod

🚫 Prohibition

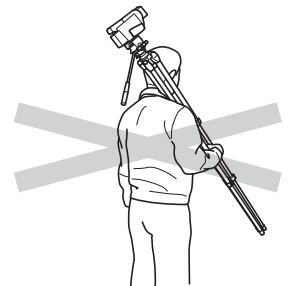

Carrying a tripod with equipment attached can result in unexpected accidents. Remove your equipment while carrying the tripod.

Setting up

⚠ Caution

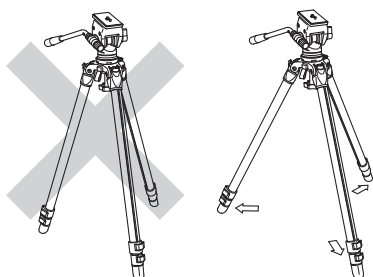

To prevent accidental equipment fall or tripod tipping over, making sure all levers, knobs and handles on the tripod are securely tightened. And all three legs are opened completely.

Install the Pan & Tilt Handle

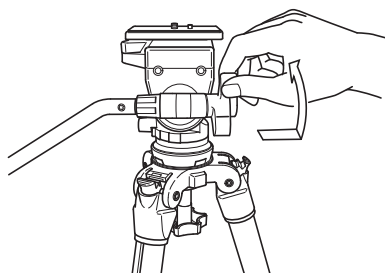

Please remove the Handle lock knob, and insert Pan & Tilt handle in the axis hole. Please tighten the knob with required angle. You can change the position of the knob when you pull the knob.

Adjust the level of pan head

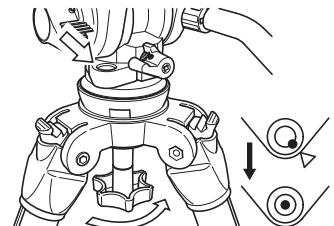

Adjust the level before putting the camera on the pan head.

- 1) Loosen the bowl lock knob and adjust the bubble in the level to fit into the red color mark.
- 2) Tighten the bowl lock knob.

* This is just rough aim and recommendable to test in advance before operating.

Attaching equipment to the quick release shoe

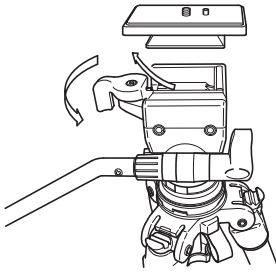

Remove the quick release shoe from the pan head by turning the shoe locking lever. Do not attempt to return the shoe locking lever by force. It remains in its open position when the quick release shoe is not in place.

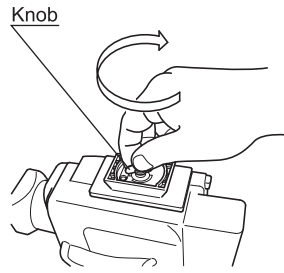

Attach your equipment to the quick release shoe after aligning the video pin with the locating hole on the base of the equipment. Fix the quick release shoe to the equipment firmly by turning the screw knob.

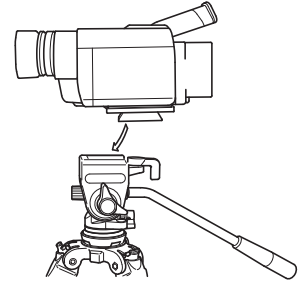

Attach the equipment onto the pan head and lock the shoe firmly with the shoe locking lever.

Using the pan head

⚠ Caution

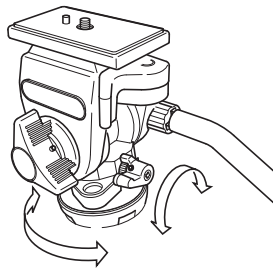
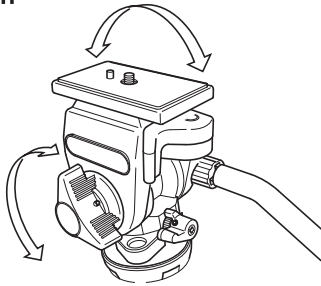

Loosen the tilt lock lever, and the head will back and forth.
Loosen the pan lock lever, and the head will rotate along the horizontal direction.
* Since the pan head has the structure of a smooth feeling on operation, it looks sometimes locked while it is unlocked actually.
Please be sure to lock a tilt lock lever when you leave from your tripod.

Leg angle adjustment

⚠ Caution

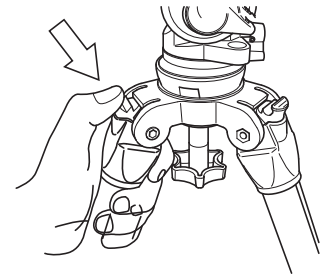

To change the angle of each leg, close the leg slightly, and push the leg angle adjustment lock out. There is a choice of two other angle positions.

Attachment Accessory

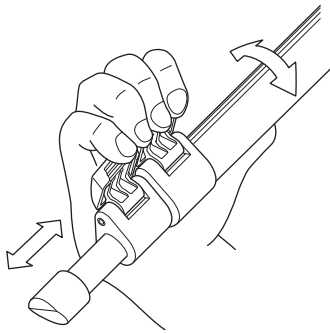

Flip up the leg lock lever to extend or shorten any of the individual leg sections to the desired length and press the leg lock lever flush against the leg to lock.



It is easier to extend the tripod legs if you turn the leg-tips to the foot, while leaving legs close.

Care of the product

- DO NOT apply any grease or oil to this product.
- Clean with a mild detergent and a soft cloth only.
- DO NOT use the unit close to flame. Avoid extreme heat.

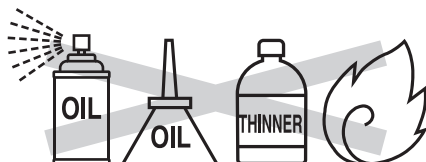

Slik Corporation reserves the right to make changes in design and/or improvements on the products without any obligation and advanced notice.

SLIK CORPORATION

853 Kayama, Hidaka City, Saitama 350-1231 Japan Phone 81-42-989-2141, Fax. 81-42-985-0210 ©2021

<http://slik.com/>