

Specification

Height	105 mm (4.2 in)
Weight	590 g (1.31 lbs)
Camera mounting screw	U1/4"
Tripod mounting screw	U1/4"

Operating Instructions

Thank you very much for choosing SLIK product. SLIK Corporation has designed to be a sturdy, rugged, dependable product that will provide you with many years of satisfactory use. Please take a few moments to read this operating instruction carefully before use so that you can take full advantage of many fine features. Retain this operating instruction in case you might want to refer back to it.

⚠ Caution

This caution icon refers to information pertaining to important safety procedures in preventing injuries, or damages which may occur as a result of mishandling this product.

🚫 Prohibition

This prohibited icon refers to information pertaining to prohibited contents. Please refer to instructions closely to avoid accidents.

V546

Components

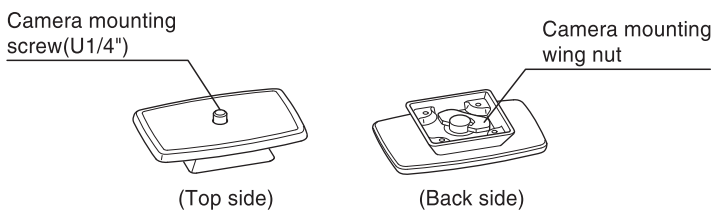
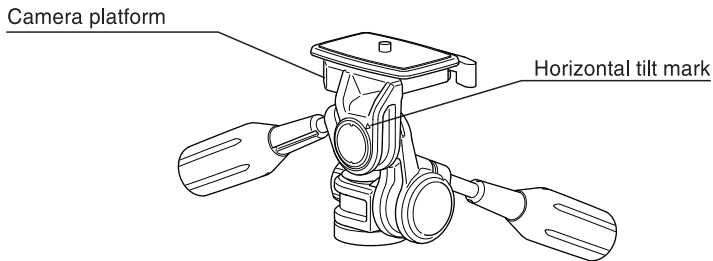
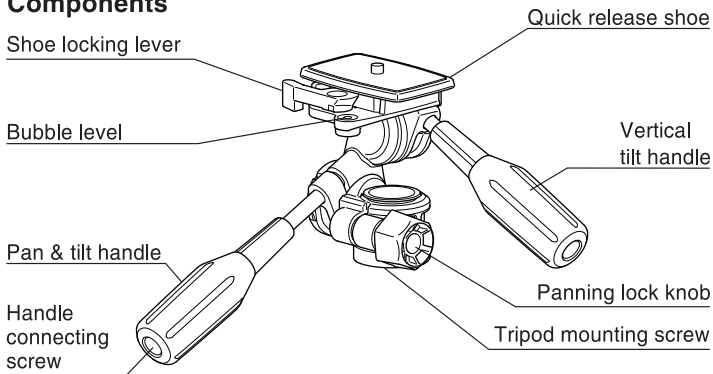

※Bubble level is a rough criterion. It is not accurate as a leveler on a camera.

Equipment that can be loaded on this product

🚫 Prohibition

Maximum loading capacity
5 kgs (11 lbs)

Do not overload.

This product has been designed to handle equipment weighing under the maximum loading capacity. Some equipments weighing under the maximum loading capacity may not balance well due to its weight distribution. Use a larger equipment in such case.

Carrying the tripod

🚫 Prohibition

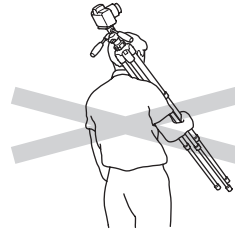

Carrying a tripod with a camera left on can result in unexpected accidents. We, therefore, recommend that you remove your camera while carrying the tripod.

Setting up

⚠ Caution

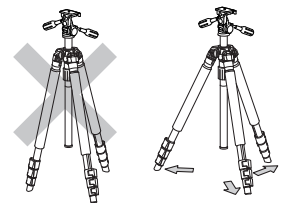

To prevent accidental equipment fall or tripod tipping over, making sure all levers, knobs and handles on the tripod are securely tightened. And all three legs are opened completely.

Install the panhandle

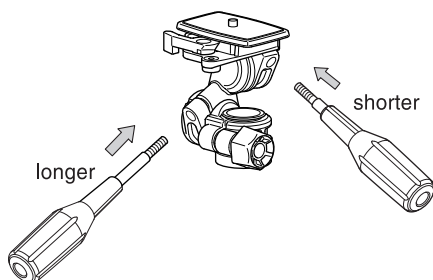

Attach the two pan handles to the pan head, by inserting the longer handle to the left, and the shorter vertical tilt handle to the right. Do not reverse.

Storage

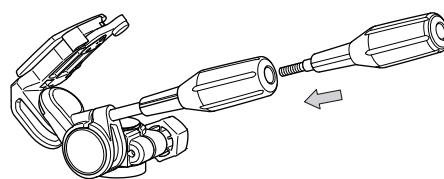

Remove the vertical tilt handle from the pan head, and screw into the back of the pan & tilt handle.

Bubble level

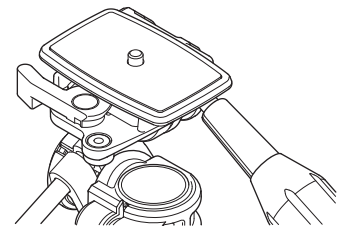

Adjust the level so that the bubble come into the circle.

Attaching the camera to the quick release shoe

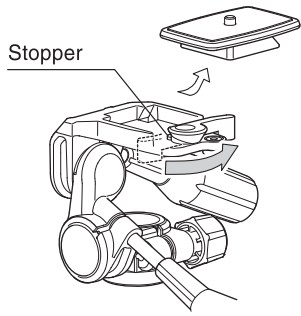

Remove the quick release shoe turning the shoe locking lever. In this case, please do not put the shoe locking lever back by force as it has been stood by the stopper.

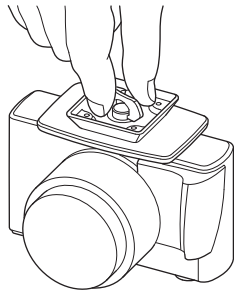

Align the length of the quick release shoe along the base of the camera body, and securely tighten the mounting wing nut.

⚠ Caution

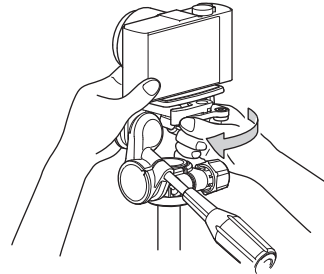

When you fix this quick release shoe to pan head, the shoe locking lever will return to the original position automatically. We, however, recommend you to tighten this lever more to secure the fixing.

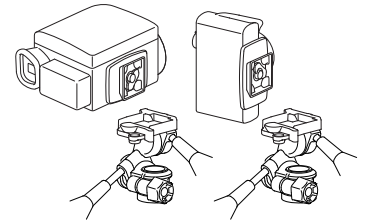

The quick release shoe can be mounted on 90 degree turned position. Easier handling for a video camera with the turned position.

Using the pan head

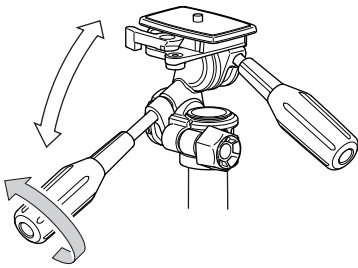

Loosen the pan & tilt handle, and the head will tilt back and forth.

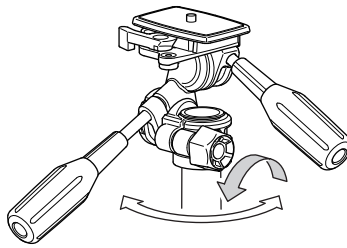

Loosen the panning lock knob, and the head will rotate along the horizontal direction.

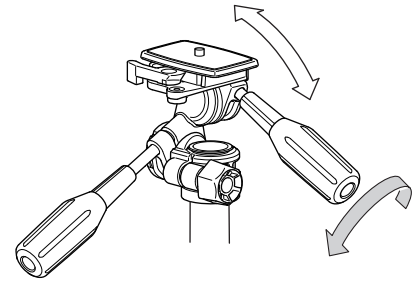

Loosen the vertical tilt handle, and the level can be adjusted.

Setting the pan head to the center column

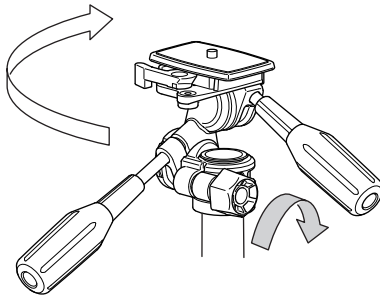

Set the head on the tripod's threaded post, and turn clockwise until it comes to a stop. Tighten the panning lock knob and turn clockwise slightly more.

Removing the pan head from the center column

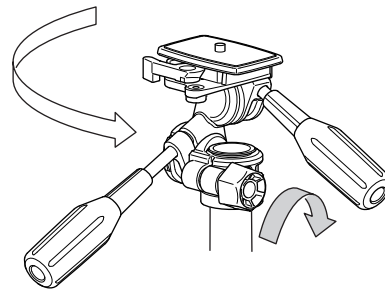

First, lock the panning lock knob, then grasp the pan, or vertical tilt handle and turn the head, counter-clockwise to loosen.

Care of the product

- DO NOT apply any grease or oil to this product.
- Clean with a mild detergent and a soft cloth only.
- DO NOT use close to flame. Avoid extreme heat.

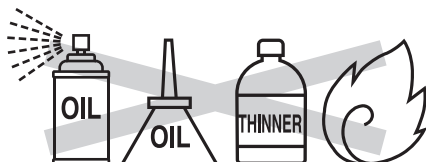

Slik Corporation reserves the right to make changes in design and/or improvements on the products without any obligation and advanced notice.